

# FOREVERLAMP HS-400D-VHO-850

PATENT PENDING

One LED lamp that replaces 400W and 250W  
**High Pressure Sodium** lamps

## Features

- Proprietary **Direct-Fit EZ install** LED technology for 400W and 250W **High Pressure Sodium** lamps.
- Nothing to rewire uses existing HPS ballast.
- Works with pulse start and probe start HPS ballasts.
- Saves up to 50% on energy costs over HPS lamps.
- Easy to install just remove your old HPS lamp and replace with **Foreverlamp LED technology**.
- 200W version delivers 22,000 lumens.
- **Typical payback** <18 months with 12 hours per day usage.
- Instant On/Off; no arc tube re-strike timeout which improves safety over HPS.
- 5000K CCT, CRI>83
- LM-80 and LM-79 reports available
- Rated lifetime >50,000 hours, saves at least 2 HPS re-lamp changes.
- Foreverlamp provides an unconditional **5 year lamp replacement warranty**.

•  UL Recognized  
E358593

- **Designed for open fixtures ONLY.**

## Model HS-400D-VHO-850

- The lamp is compatible with 400W and 250W **High Pressure Sodium** ballast without any re-wiring of the fixture.
- Not compatible with other types of ballasts.

## Foreverlamp Inc.

 406 Amapola Ave. Suite 100,  
Torrance, CA 90501, USA

 1-844-533-8811

 1-310-320-8814

 sales@foreverlamp.com

 www.foreverlamp.com

## Optimized light levels

The HS-400 Lamp incorporates constant light output circuitry to maintain light levels throughout its long life.

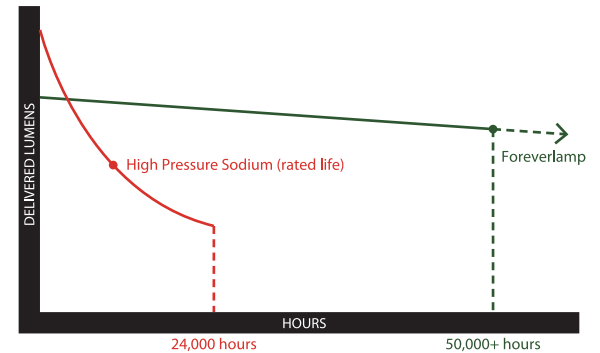

## Product Appearance



We reserve the right to modify specifications  
without prior notice April 2016

**foreverlamp**<sup>®</sup>

# FOREVERLAMP HS-400D-VHO-850

PATENT PENDING

One LED lamp that replaces 400W and 250W  
High Pressure Sodium lamps

## Product Specifications

When Used With:	400W MH Ballast	250W MH Ballast
<b>Illumination</b>		
Color Rendering Index	>83	>83
Kelvin Temperature	5000 K	5000 K
Total Lumens*	22,000 lm	14,000 lm
LED Lamp Efficacy	110 lm/W	108 lm/W
Rated Lumen Maintenance (L70)	50,000+ hours life	50,000+ hours life
<b>Electrical</b>		
Compatible Input Voltages	120V, 208V, 240V, 277V, 347V & 480V	
Lamp Wattage*	200 W	130 W
Lamp Wattage Replaced	400 W	250 W
Lamp Watts Saved	200 W	120 W
Accumulated Savings over 50,000hrs based on \$0.12/kWh	\$1,200	\$720
<b>Physical</b>		
Dimensions (H x D)	9.06" x 6.63"	
Weight	2.30 lbs	
<b>Environment</b>		
Ambient Temperature	-4°F to +131°F / -20°C to +55°C (open fixtures only)	
Relative Humidity	15% to 85%, non-condensing	
<b>Installation</b>		
Socket Type	For use with vertical mogul base - E39/EX39/E40	
<b>Certifications &amp; Qualifications</b>		
Approvals	UL / R	
RoHS Compliant	Contains no lead / no mercury	
LM79 / LM80 Reports	Available upon request	
<b>Warranty</b>		
Warranty	5 years	

\* Lumen output and power consumption  $\pm 5\%$ , based on actual magnetic ballasts.

## Foreverlamp Inc.

406 Amapola Ave. Suite 100,  
Torrance, CA 90501, USA

1-844-533-8811

1-310-320-8814

sales@foreverlamp.com

www.foreverlamp.com

We reserve the right to modify specifications  
without prior notice April 2016

foreverlamp®

# FOREVERLAMP HS-400D-VHO-850

PATENT PENDING

One LED lamp that replaces 400W and 250W  
High Pressure Sodium lamps

## Product Dimensions

Measurements are rounded up. Dimensions are shown in inches.

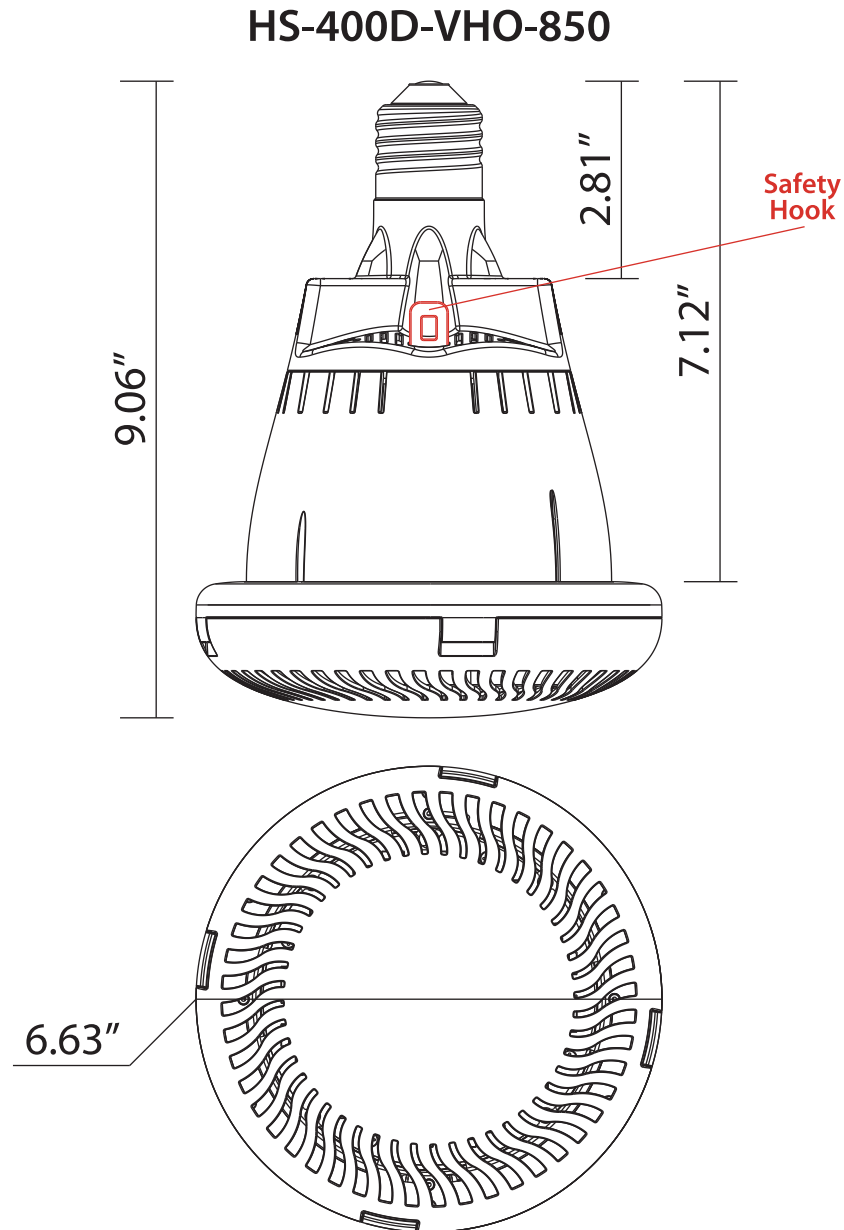

Weight: 2.30 lbs

### Foreverlamp Inc.

406 Amapola Ave. Suite 100,  
Torrance, CA 90501, USA

1-844-533-8811

1-310-320-8814

sales@foreverlamp.com

www.foreverlamp.com

We reserve the right to modify specifications  
without prior notice April 2016

**forever**lamp®